

*1The finished tower*

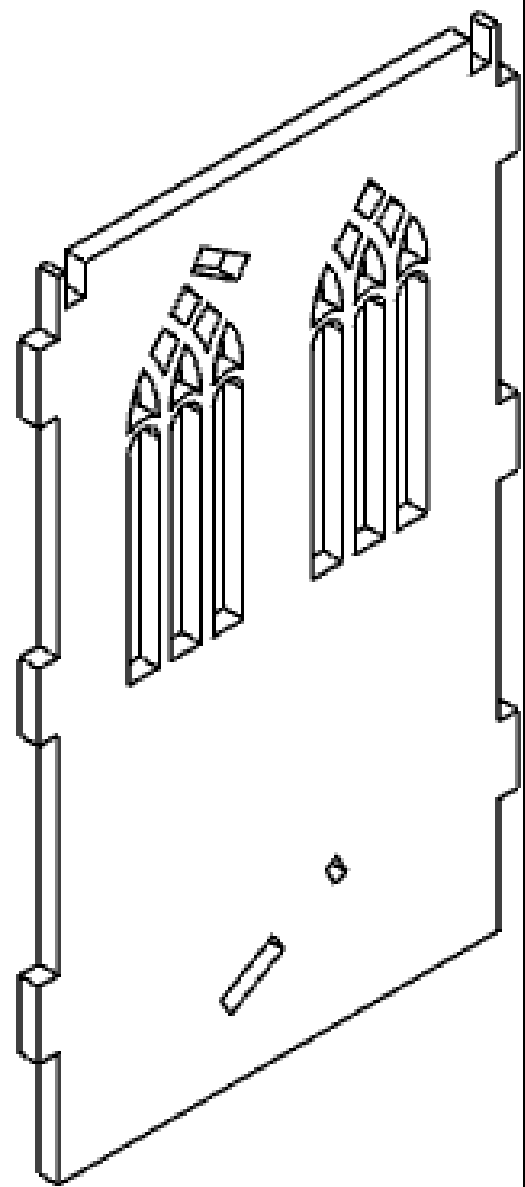

*2Take the first side piece and keep the textured side away from you*

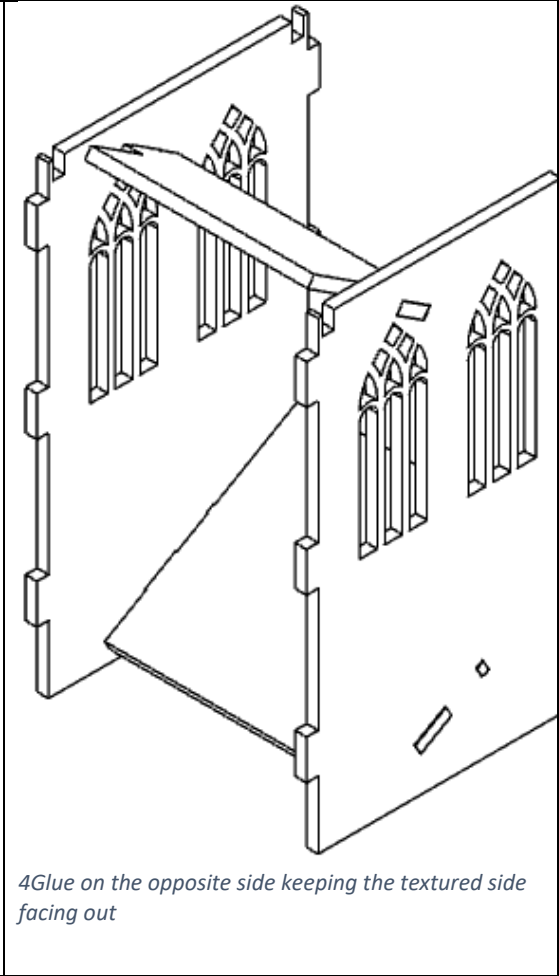

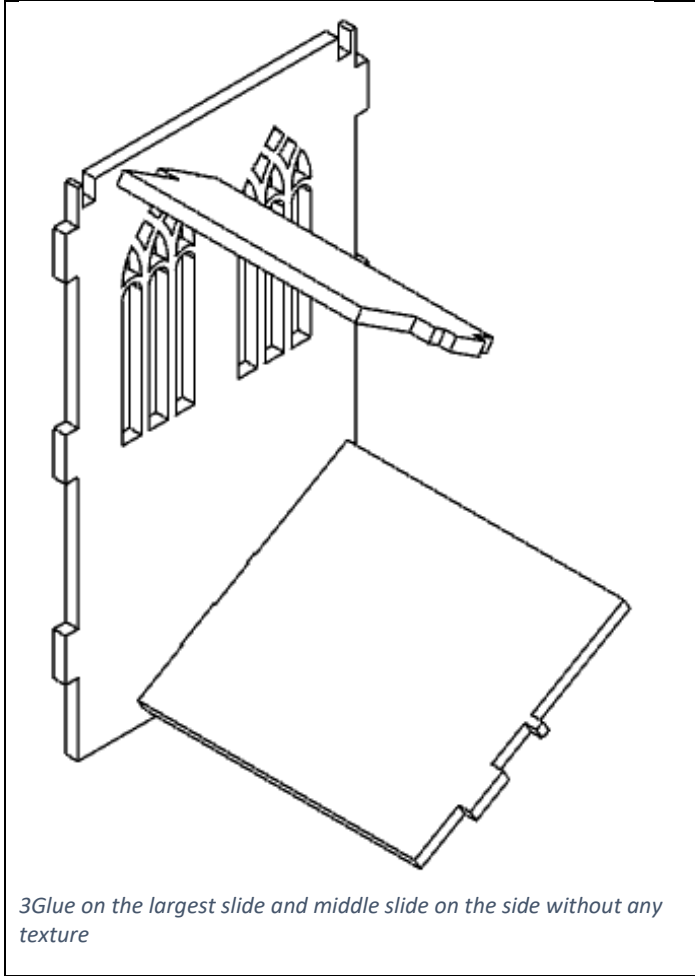
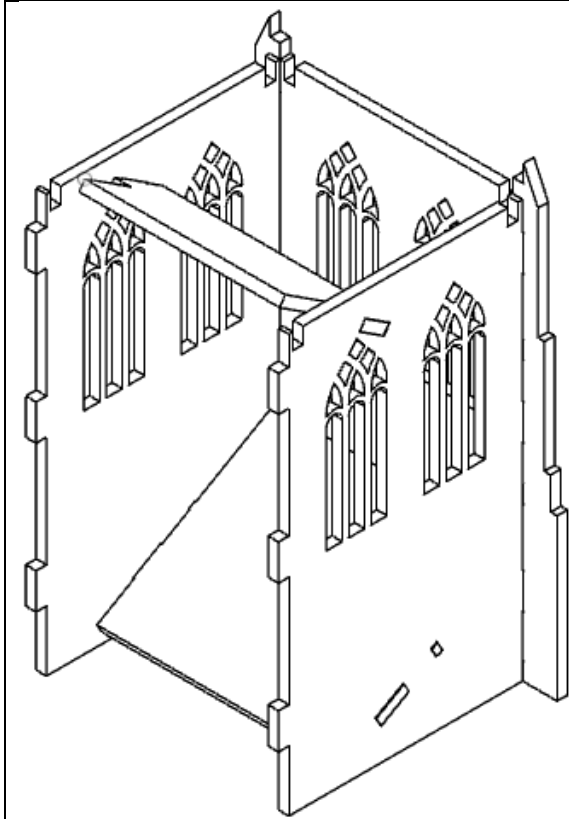

*5 Glue on the rear face*

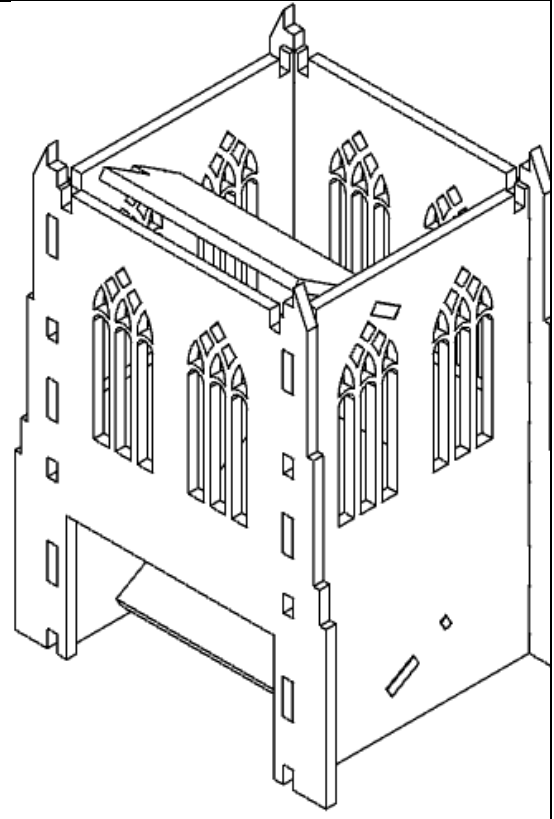

*6 Glue on the front face (has a rectangular cut-out on the bottom)*

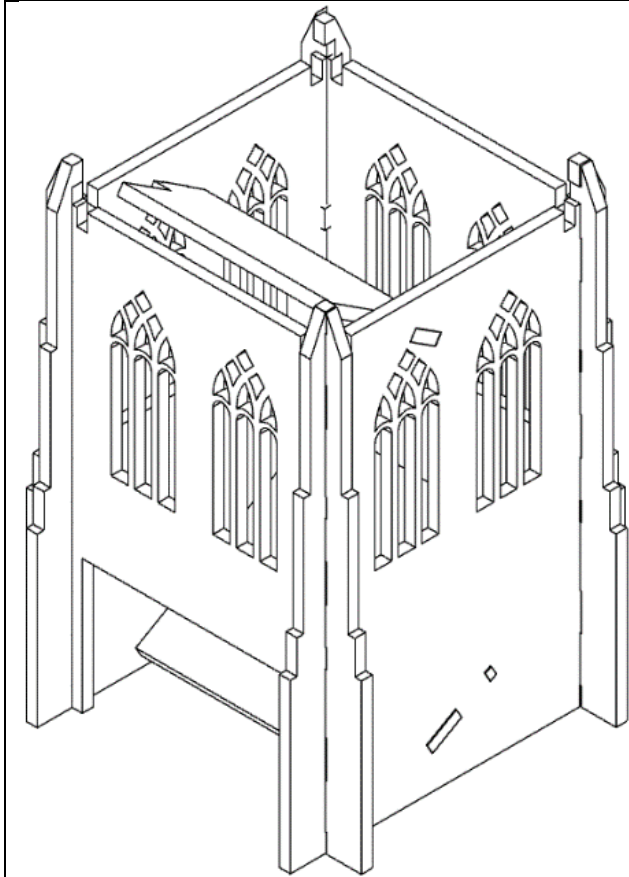

*7 Glue on the large buttresses*

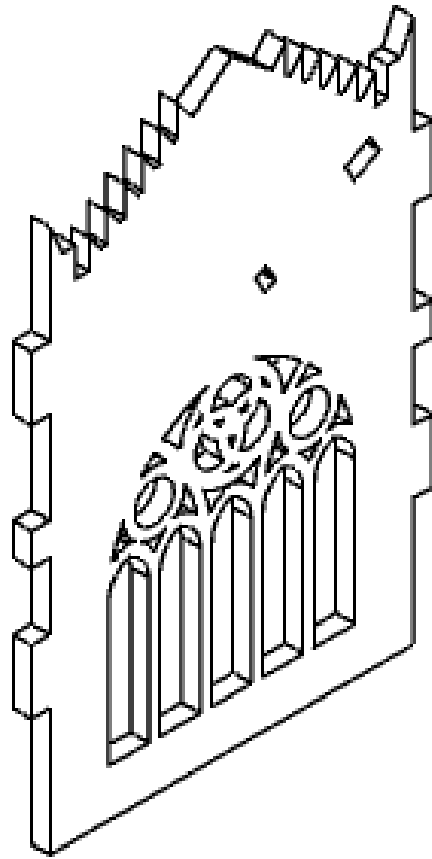

*8 Take one of the top side pieces, keep the textured side facing away from you.*

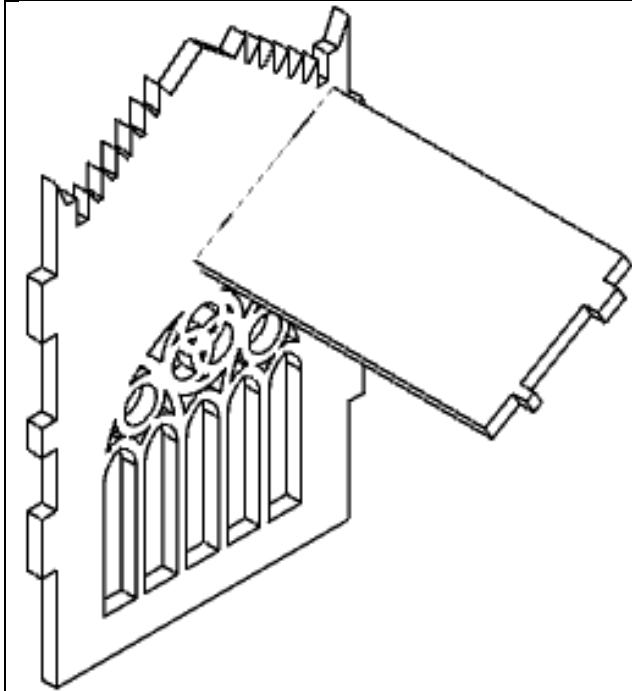

9 Glue on the upper slide

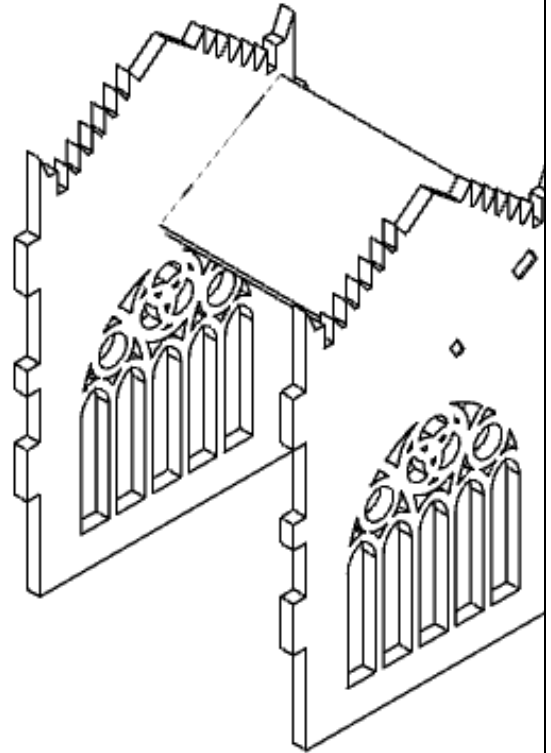

10 Glue on the opposite side, keeping the textured side facing outward

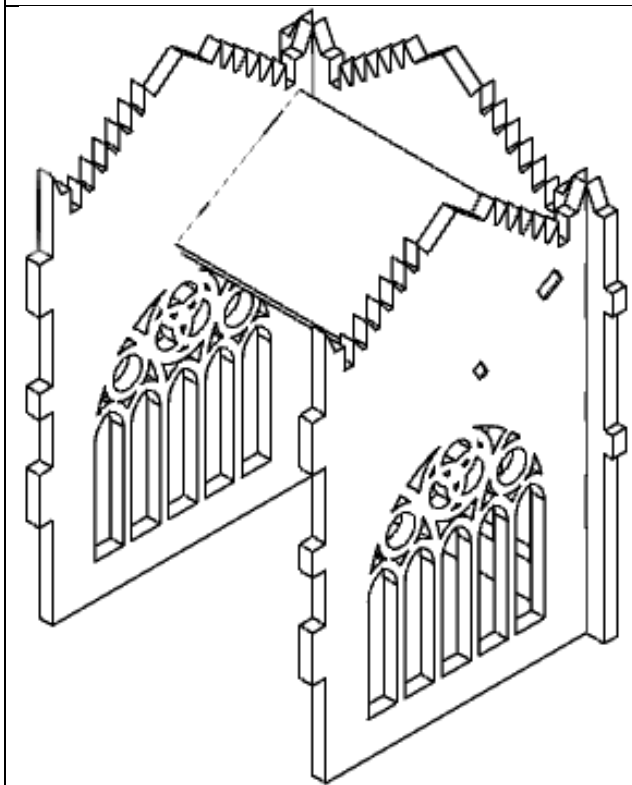

11 Glue on the rear face, keeping the textured side facing outward

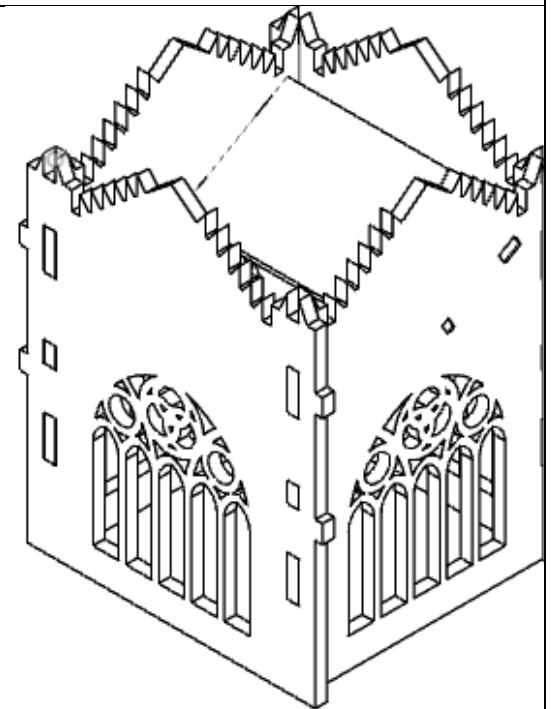

12 Glue on the front face, keeping the textured side facing outward

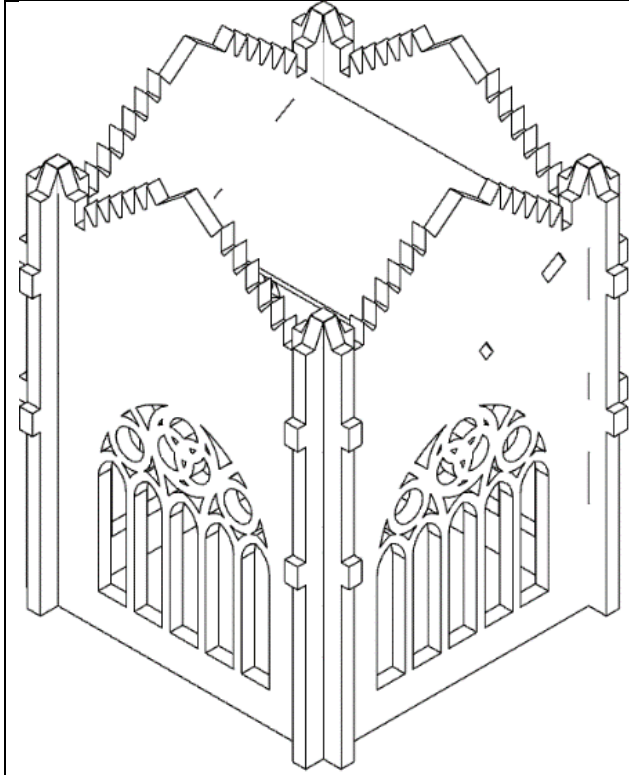

13 Glue on the upper buttresses

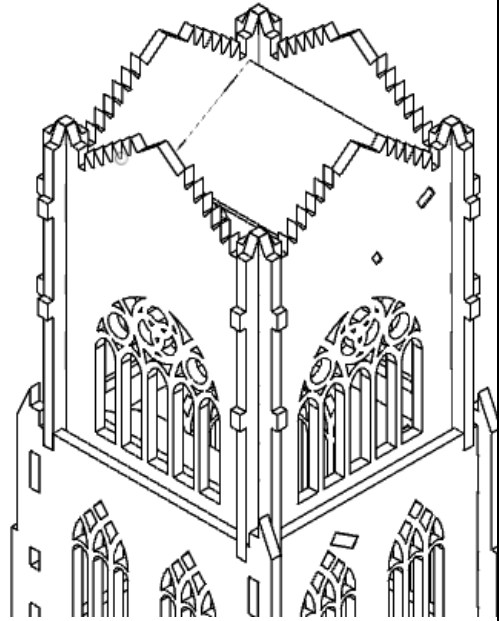

14 Glue on the top section to the bottom half. The buttresses should slot into the channels on the top of the lower section.

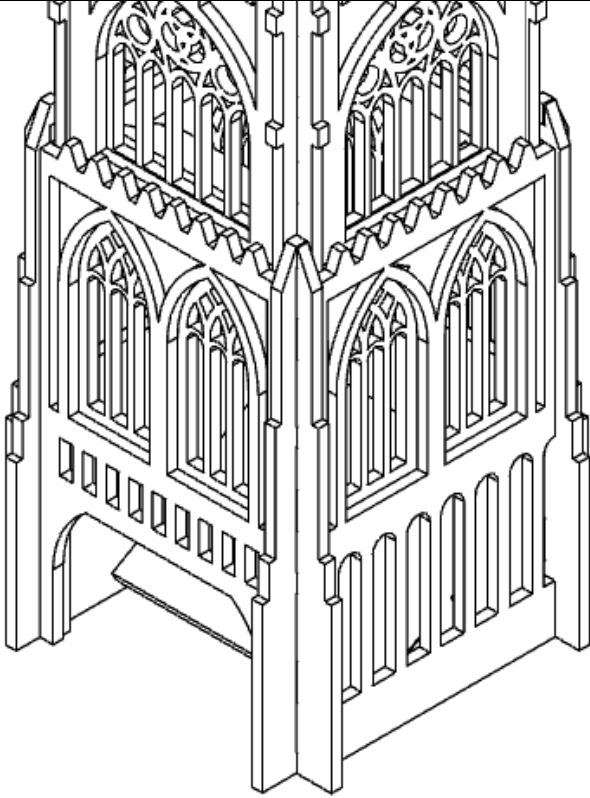

*15 Glue on the additional detailed layers. The front lower detailed layer has a cutout on the bottom.*